

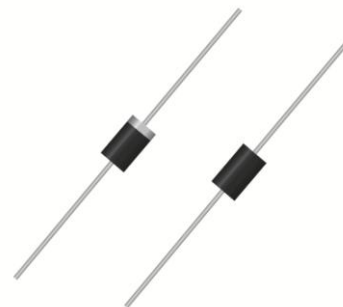
Transient Voltage Suppression Diodes: P6KE Series

Axial Leaded Type 600 W



■ Features

1. Reliable low cost construction utilizing molded plastic technique
2. Both bi-directional and uni-directional devices are available
3. Fast response time
4. Excellent clamping capacity
5. 600 W peak pulse power capability with a 10/1000 μ s waveform, repetition rate (duty cycle): 0.01%



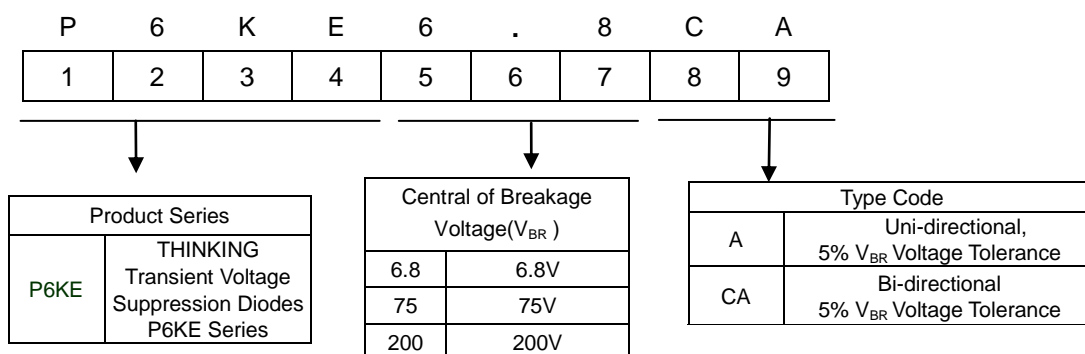
■ Recommended Applications

1. Telecommunication
2. Computer
3. Industrial device
4. Consumer electronic device

■ Mechanical Data

1. Package: DO-15(DO-204AC)
2. Terminal: Matte Tin-plated leads, solderable per MIL-STD-750, Method 2026.
3. Polarity: The band denotes cathode (Note: no polarity indicator for bi-directional devices)

■ Part Number Code



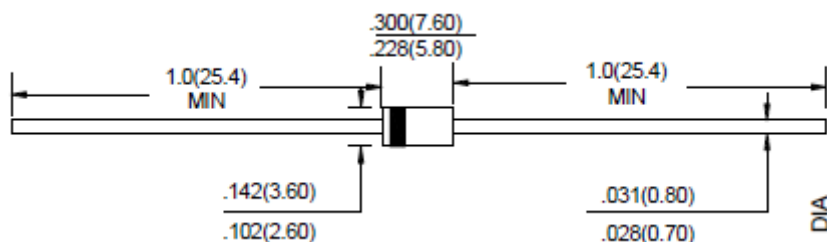
Transient Voltage Suppression Diodes: P6KE Series

Axial Leaded Type 600 W



■ Structures and Dimensions

DO-15(DO-204AC)



Unit: inch(millimeter)

■ Maximum Rating ($T_A=25^{\circ}\text{C}$ unless otherwise noted)

Parameter	Symbol	Value	Unit
Peak pulse power dissipation at $T_A=25^{\circ}\text{C}$ by 10/1000 μs waveform.	P_{PPM}	600	W
Peak Pulse Current of on 10/1000 μs waveform.	I_{PPM}	See Table	A
Peak forward surge current, 8.3ms single half sine wave on rated load.	I_{FSM}	100	A
Steady State Power Dissipation at $T_L=75^{\circ}\text{C}$.	P_D	5.0	W
Operating junction and storage temperature range	T_J, T_{STG}	-55~+150	$^{\circ}\text{C}$

Transient Voltage Suppression Diodes: P6KE Series

Axial Leaded Type 600 W



■ Electrical Characteristics (T_A=25°C unless otherwise noted)

Part No. (Uni)	Part No. (Bi)	Reverse Stand off Voltage	Breakage Voltage V _{BR} @ I _T		Test Current	Maximum Clamping Voltage V _C @ I _{pp}	Maximum Peak Pulse Current	Maximum Reverse Leakage I _R @ V _{RWM}
		V _{RWM} (V)	Min(V)	Max(V)	I _T (mA)	V _C (V)	I _{pp} (A)	I _R (μA)
P6KE6.8A	P6KE6.8CA	5.8	6.5	7.1	10	10.5	57.1	1000
P6KE7.5A	P6KE7.5CA	6.4	7.1	7.9	10	11.3	53.1	500
P6KE8.2A	P6KE8.2CA	7.0	7.8	8.6	10	12.1	49.6	200
P6KE9.1A	P6KE9.1CA	7.8	8.7	9.6	1	13.4	44.8	50
P6KE10A	P6KE10CA	8.6	9.5	10.5	1	14.5	41.4	10
P6KE11A	P6KE11CA	9.4	10.5	11.6	1	15.6	38.5	5
P6KE12A	P6KE12CA	10.2	11.4	12.6	1	16.7	35.9	5
P6KE13A	P6KE13CA	11.1	12.4	13.7	1	18.2	33.0	5
P6KE15A	P6KE15CA	12.8	14.3	15.8	1	21.2	28.3	5
P6KE16A	P6KE16CA	13.6	15.2	16.8	1	22.5	26.7	5
P6KE18A	P6KE18CA	15.3	17.1	18.9	1	25.2	23.8	5
P6KE20A	P6KE20CA	17.1	19.0	21.0	1	27.7	21.7	5
P6KE22A	P6KE22CA	18.8	20.9	23.1	1	30.6	19.6	5
P6KE24A	P6KE24CA	20.5	22.8	25.2	1	33.2	18.1	5
P6KE27A	P6KE27CA	23.1	25.7	28.4	1	37.5	16.0	5
P6KE30A	P6KE30CA	25.6	28.5	31.5	1	41.4	14.5	5
P6KE33A	P6KE33CA	28.2	31.4	34.7	1	45.7	13.1	5
P6KE36A	P6KE36CA	30.8	34.2	37.8	1	49.9	12.0	5
P6KE39A	P6KE39CA	33.3	37.1	41.0	1	53.9	11.1	5
P6KE43A	P6KE43CA	36.8	40.9	45.2	1	59.3	10.1	5
P6KE47A	P6KE47CA	40.2	44.7	49.4	1	64.8	9.3	5
P6KE51A	P6KE51CA	43.6	48.5	53.6	1	70.1	8.6	5
P6KE56A	P6KE56CA	47.8	53.2	58.8	1	77.0	7.8	5
P6KE62A	P6KE62CA	53.0	58.9	65.1	1	85.0	7.1	5
P6KE68A	P6KE68CA	58.1	64.6	71.4	1	92.0	6.5	5
P6KE75A	P6KE75CA	64.1	71.3	78.8	1	103.0	5.8	5
P6KE82A	P6KE82CA	70.1	77.9	86.1	1	113.0	5.3	5
P6KE91A	P6KE91CA	77.8	86.5	95.5	1	125.0	4.8	5
P6KE100A	P6KE100CA	85.5	95.0	105.0	1	137.0	4.4	5

Transient Voltage Suppression Diodes: P6KE Series

Axial Leaded Type 600 W



■ Electrical Characteristics ($T_A=25^{\circ}\text{C}$ unless otherwise noted)

Part No. (Uni)	Part No. (Bi)	Reverse Stand off Voltage	Breakage Voltage V_{BR} @ I_T		Test Current	Maximum Clamping Voltage V_C @ I_{pp}	Maximum Peak Pulse Current	Maximum Reverse Leakage I_R @ V_{RWM}
		V_{RWM} (V)	Min(V)	Max(V)	I_T (mA)	V_C (V)	I_{pp} (A)	I_R (μ A)
P6KE110A	P6KE110CA	94.0	105.0	116.0	1	152.0	3.9	5
P6KE120A	P6KE120CA	102.0	114.0	126.0	1	165.0	3.6	5
P6KE130A	P6KE130CA	111.0	124.0	137.0	1	179.0	3.4	5
P6KE150A	P6KE150CA	128.0	143.0	158.0	1	207.0	2.9	5
P6KE160A	P6KE160CA	136.0	152.0	168.0	1	219.0	2.7	5
P6KE170A	P6KE170CA	145.0	162.0	179.0	1	234.0	2.6	5
P6KE180A	P6KE180CA	154.0	171.0	189.0	1	246.0	2.4	5
P6KE200A	P6KE200CA	171.0	190.0	210.0	1	274.0	2.2	5
P6KE220A	P6KE220CA	185.0	209.0	231.0	1	328.0	1.8	5
P6KE250A	P6KE250CA	214.0	237.0	263.0	1	344.0	1.7	5
P6KE300A	P6KE300CA	256.0	285.0	315.0	1	414.0	1.4	5
P6KE350A	P6KE350CA	300.0	333.0	368.0	1	482.0	1.2	5
P6KE400A	P6KE400CA	342.0	380.0	420.0	1	548.0	1.1	5
P6KE440A	P6KE440CA	376.0	418.0	462.0	1	602.0	1.0	5

Transient Voltage Suppression Diodes: P6KE Series

Axial Leded Type 600 W



Rate and Characteristic Curve ($T_A=25^\circ\text{C}$ unless otherwise noted)

图1: 最大脉冲功率曲线
FIG1: Peak Pulse Power Rating Curve

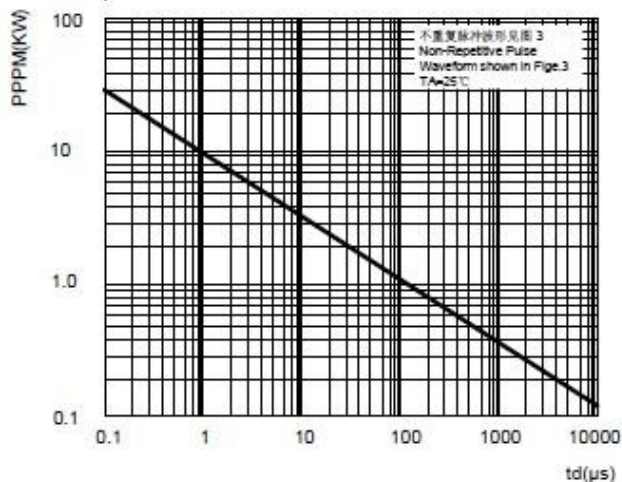


图2: 脉冲功率或电流与结温关系
FIG2: Pulse Power or Current vs. Initial Junction Temperature

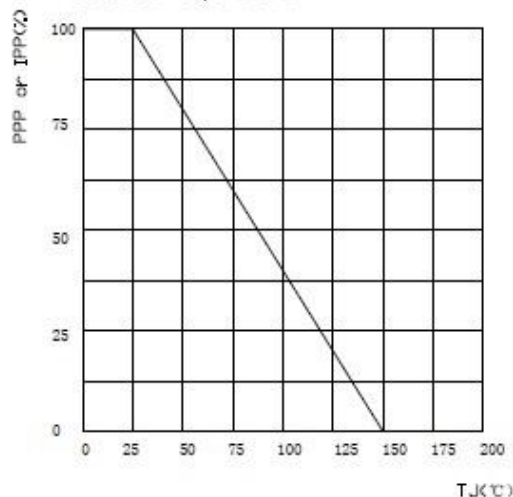


FIG.3 - PULSE WAVEFORM

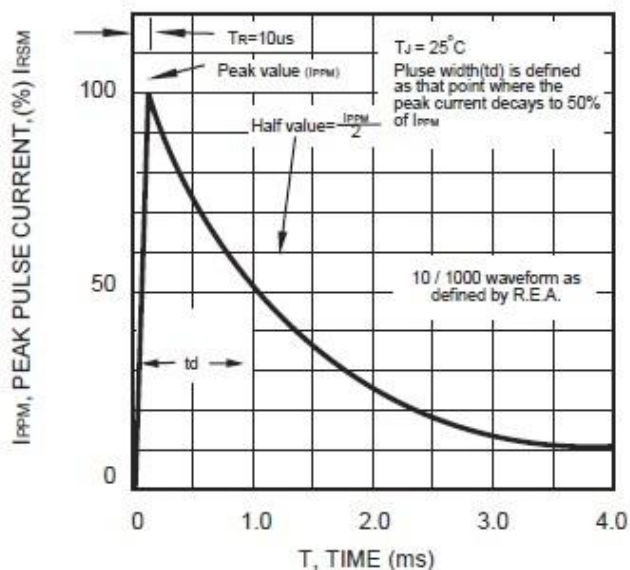
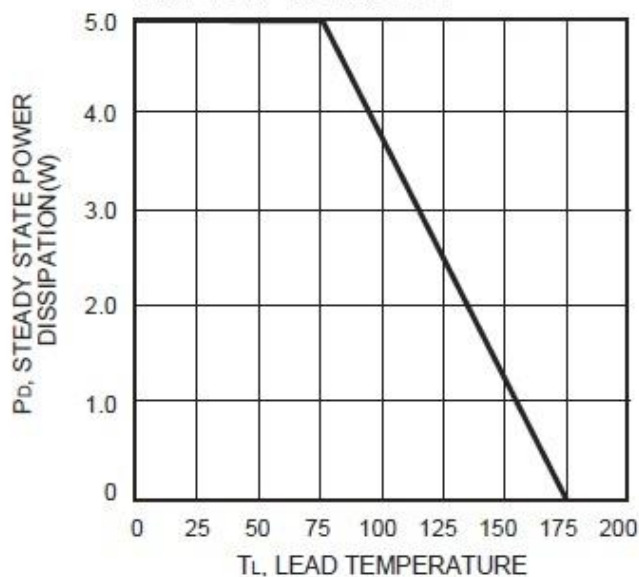


图4: 功率降额曲线
FIG4: Power Derating Curve

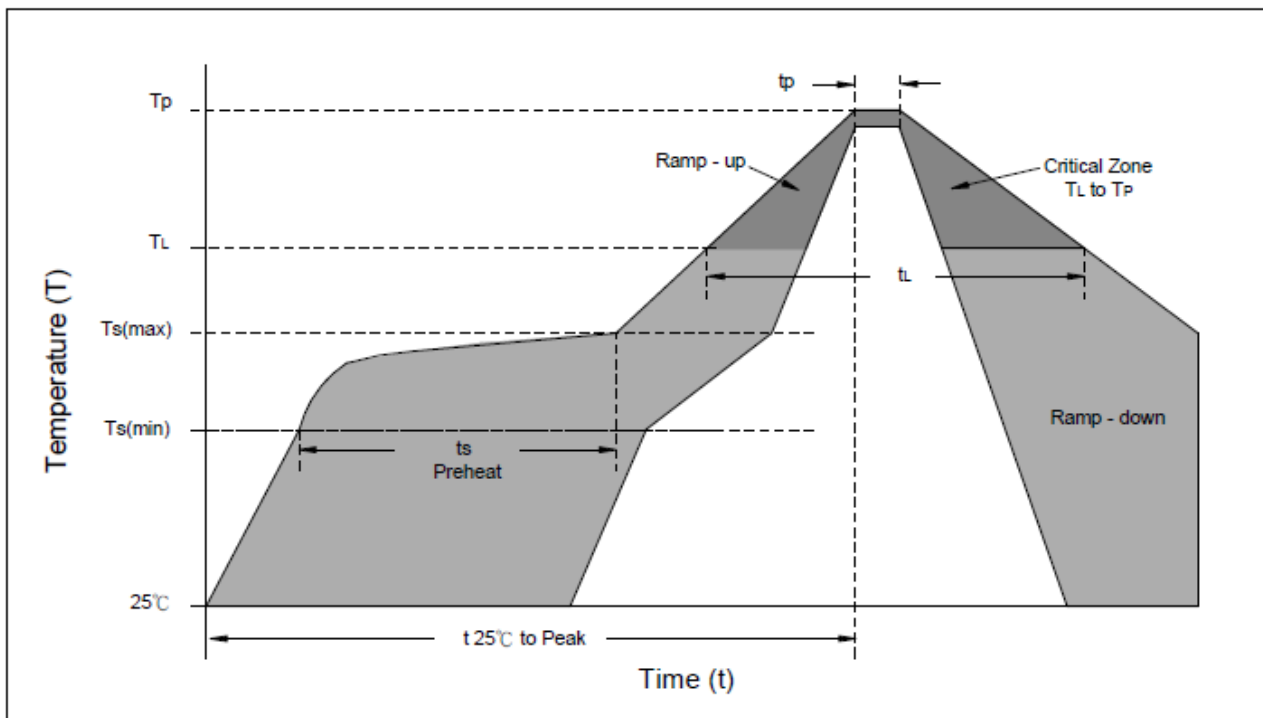


Transient Voltage Suppression Diodes: P6KE Series

Axial Leaded Type 600 W



■ Soldering Recommendation



Reflow Condition	Lead-free assembly
Preheat -Temperature Min(Ts min) -Temperature Min(Ts max) -Time (min to max) (ts)	150°C 200°C 60 – 180 seconds
Average ramp up rate -Temperature Liquidus (TL) to peak	3°C/second max
Ts(max) to TL -Ramp-up Rate	3°C/second max.
Reflow -Temperature Liquidus (TL) -Time (tL)	217°C 60 – 150 seconds
Peak Temperature (TP)	260°C
Time within 5°C of actual peak Temperature(TP)	20 – 40 seconds
Ramp-down Rate	6°C/second max.
Time 25°C to peak Temperature(TP)	8 minutes max.
Do not exceed	260°C

Transient Voltage Suppression Diodes: P6KE Series

Axial Leaded Type 600 W



■ Quantity

Package Type	Reel Size inch	Reel Kpcs
DO-15	13	4

■ Warehouse Storage Conditions of product

- Storage condition:
 - 1.Storage Temperature: $-10^{\circ}\text{C} \sim +40^{\circ}\text{C}$
 - 2.Relative Humidity: $\leq 75\%RH$
 - 3.Keep away from corrosive atmosphere and sunlight.
- Period of Storage: 1 year.