

Thyristor Surge Suppressors : TSSxxxxSB Series

SMD Type, SMB/DO-214AA @10/700 μ S, 4KV



■ Features

1. Precious and stable voltage
2. Low leakage current
3. Low on-state voltage
4. Low capacitance
5. Component fails short circuit when surged in excess of ratings
6. Component properties do not degrade after multiple surge events within its limits
7. RoHS Compliant and Halogen-Free



■ Recommended Applications

1. Communications equipment (RS232/RS485/RJ45/RJ11/COAXIAL)
2. Alarm/Camera
3. Component is used in series with an appropriate overvoltage clamp device to protect a power supply from damage due to an overvoltage condition on its AC input lines.

■ Mechanical Data

1. Case:DO-214AC molded plastic
2. Epoxy: UL 94V-0 rate flame retardant

■ Part Number Code

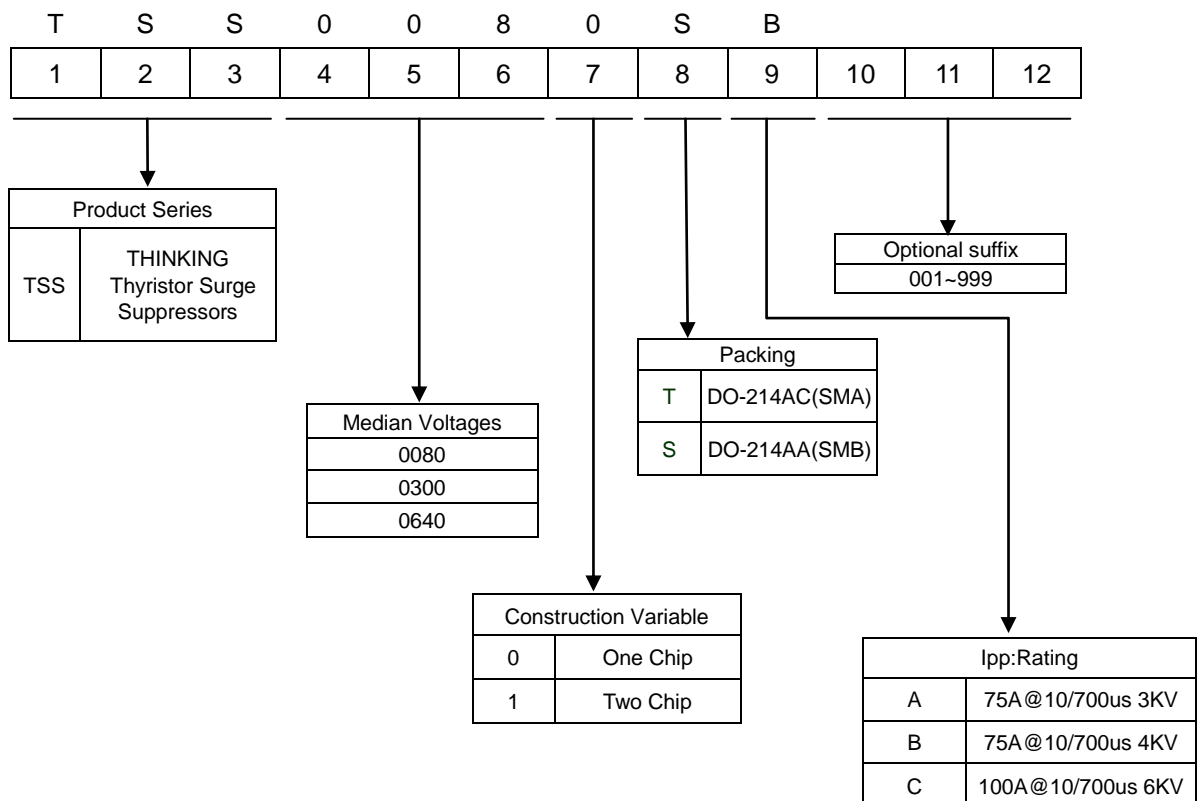

Structures and Dimensions

SMB/DO-214AA

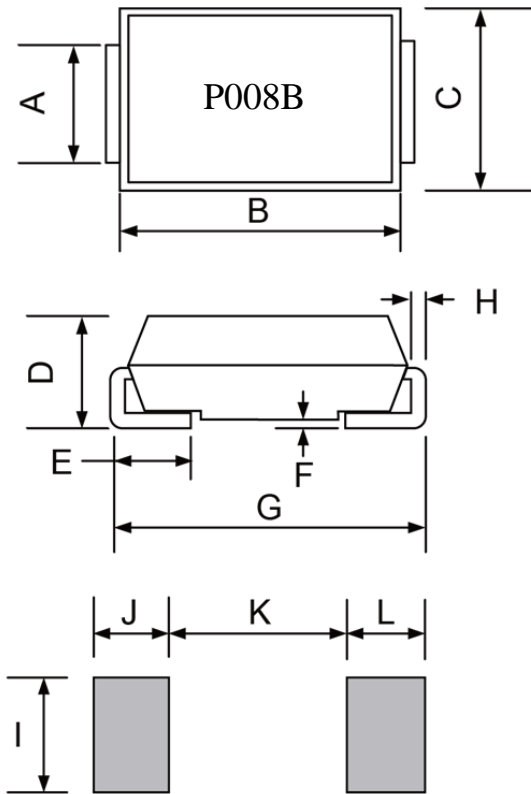

Schematic Symbol

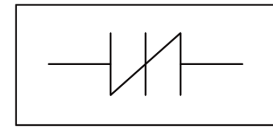

Item	Millimeters		Inches	
	Min.	Max.	Min.	Max.
A	1.80	2.20	0.071	0.086
B	4.05	4.65	0.160	0.183
C	3.30	3.94	0.130	0.155
D	2.05	2.45	0.810	0.096
E	0.76	1.52	0.030	0.060
F	-	0.203	-	0.008
G	5.08	5.59	0.200	0.220
H	0.152	0.305	0.006	0.012
I	2.26	-	0.089	-
J/L	2.160	-	0.085	-
K	-	2.740	-	0.107

Electrical Parameters

Parameter	Definition
VDRM	Peak Off-state Voltage: maximum voltage that can be applied while maintaining off state
VS	Switching Voltage: maximum voltage prior to switching to on state
VT	On-state Voltage: maximum voltage measured at rated on-state current
IDRM	Leakage Current: maximum peak off-state current measured at VDRM
IS	Switching Current: maximum current required to switch to on state
IT	On-state Current: maximum rated continuous on-state current
IH	Holding Current: minimum current required to maintain on state
CO	Off-state Capacitance: typical capacitance measured in off state

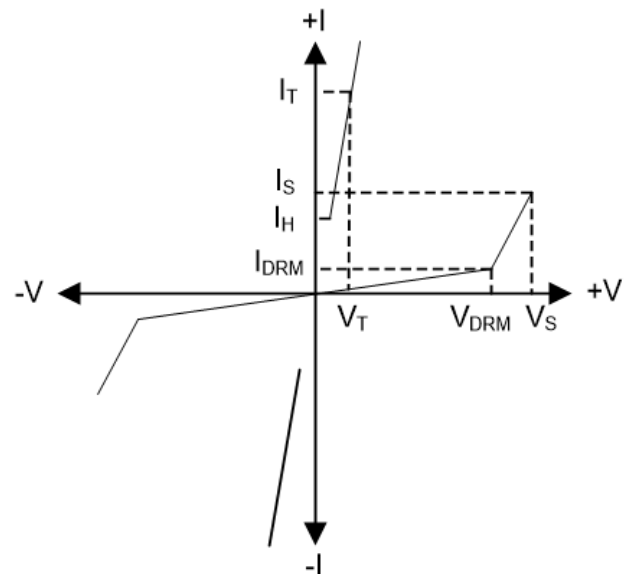

V-I Characteristic

Thyristor Surge Suppressors : TSSxxxxSB Series

SMD Type, SMB/DO-214AA @10/700 μ S, 4KV



■ Electrical Characteristics

Part Number	Marking	Peak Off-state Voltage	Switching Voltage	On-state Voltage	Leakage Current	Switching Current	On-state Current	Holding Current	Off-state Capacitance	Peak Pulse Voltage	Peak Pulse Current
		VDRM@ IDRM=5 μ A	VS@ 100V/ μ s	VT@ IT=2.2A	IDRM	IS	IT	IH	CO@ 1MHz	VPP@ 10/700 μ s	IPP@ 10/700 μ s
		(V)min	(V)max	(V)max	(μ A)max	(mA)max	(A)max	(mA)min	(pF) max	(V)	(A)
TSS0080SB	P008B	6	25	4	5	800	2.2	50	100	4000	75
TSS0300SB	P030B	25	40	4	5	800	2.2	50	100	4000	75
TSS1100SB	P110B	90	130	4	5	800	2.2	150	90	4000	75
TSS1300SB	P130B	120	160	4	5	800	2.2	150	90	4000	75
TSS1500SB	P150B	140	180	4	5	800	2.2	150	85	4000	75
TSS1800SB	P180B	170	220	4	5	800	2.2	150	85	4000	75
TSS2300SB	P230B	190	260	4	5	800	2.2	150	80	4000	75
TSS2600SB	P260B	220	300	4	5	800	2.2	150	80	4000	75

Note:

- (1) Absolute maximum ratings measured at TA= 25°C (unless otherwise noted).
- (2) Devices are bi-directional.
- (3) IPP ratings applicable to temperature range of -40°C to +85°C.
- (4) Off-state capacitance (CO) is measured at 1 MHz with a 2 V bias, and which is a typical value.

■ Thermal Considerations

Package	Symbol	Parameter	Value	Unit
SMB/DO-214AA	TJ	Operating Junction Temperature	-40 to +150	°C
	Ts	Storage Temperature Range	-40 to +150	°C
	RJA	Junction to Ambient on printed circuit	90	°C/W

■ Characteristics Curves

Figure 1.V-I Characteristic

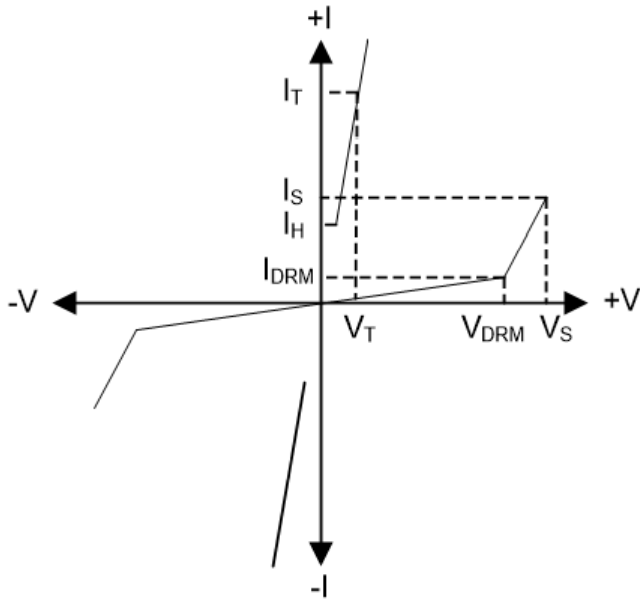

Figure 2. tr x td Pulse Wave-form

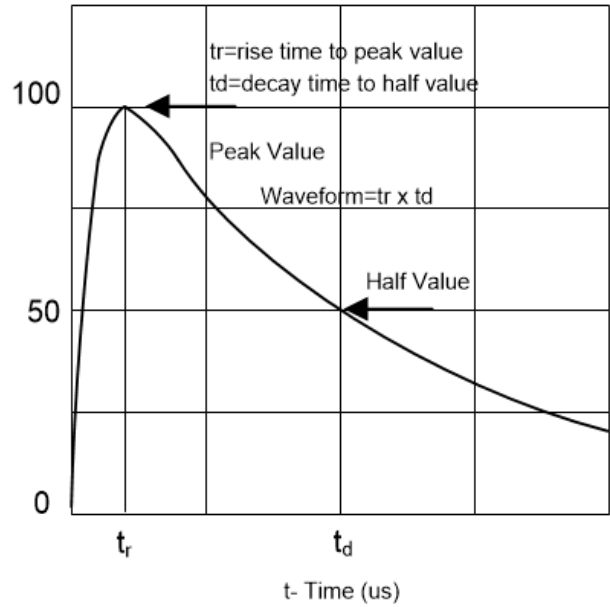

Figure 3. Normalized V_S Change versus Junction Temperature

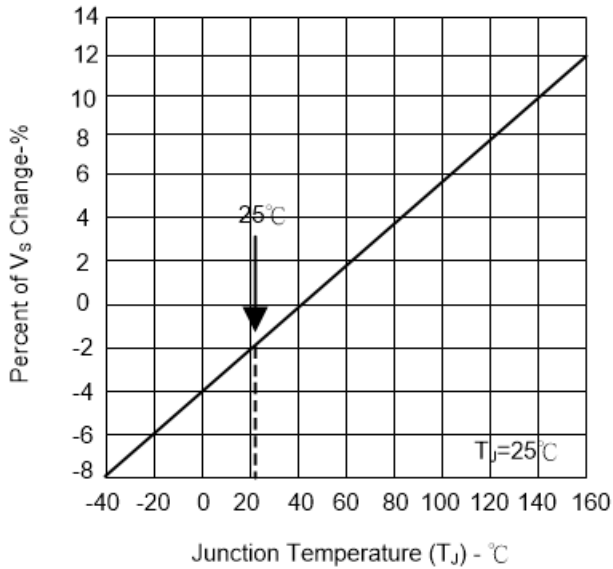
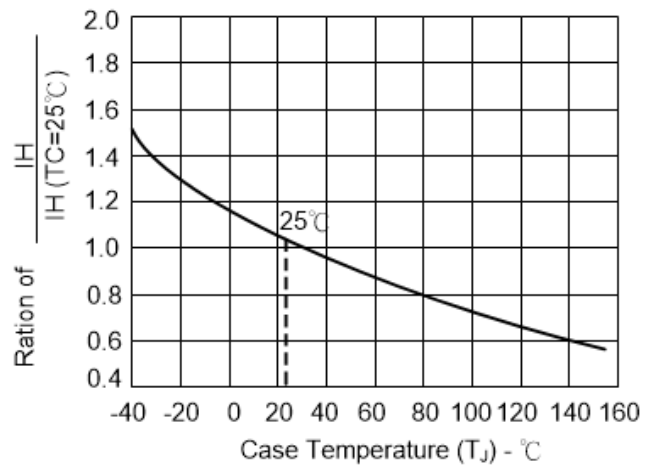

Figure 4. Normalized DC Holding Current versus Case Temperature





■ Soldering Recommendation

● IR-reflow soldering profile

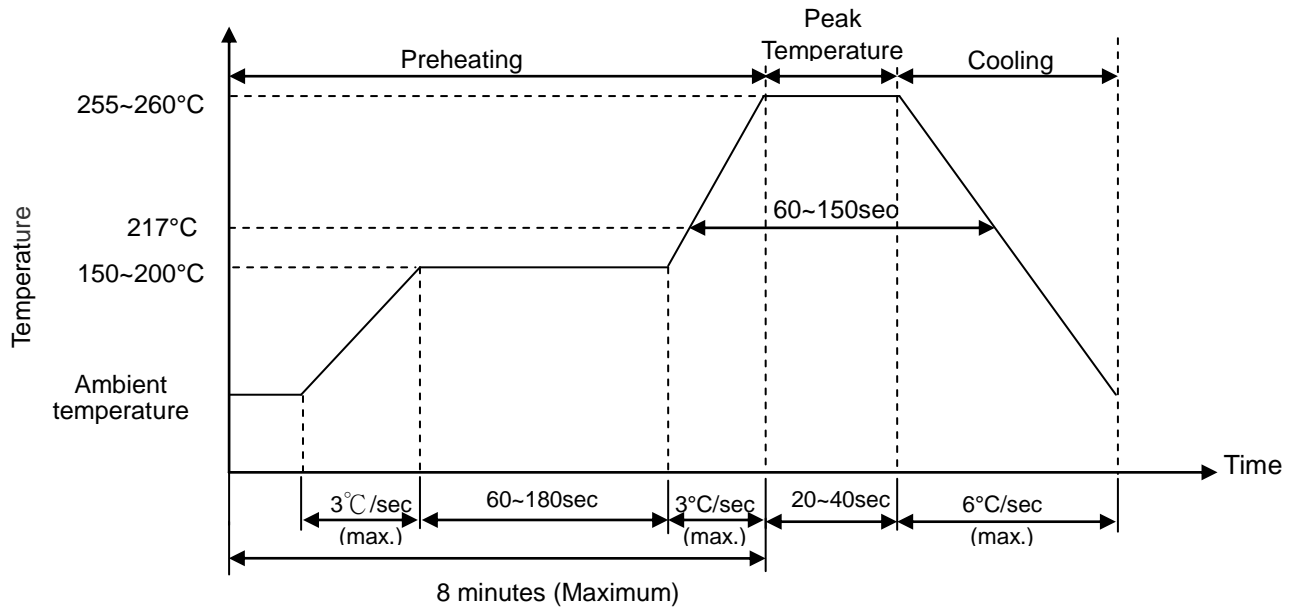

● Recommended Reworking Conditions with Soldering Iron

Item	Conditions
Temperature of Soldering Iron-tip	360°C (max.)
Soldering Time	3 sec (max.)
Diameter of Soldering Iron-tip	Φ 3mm (max.)

■ Packaging

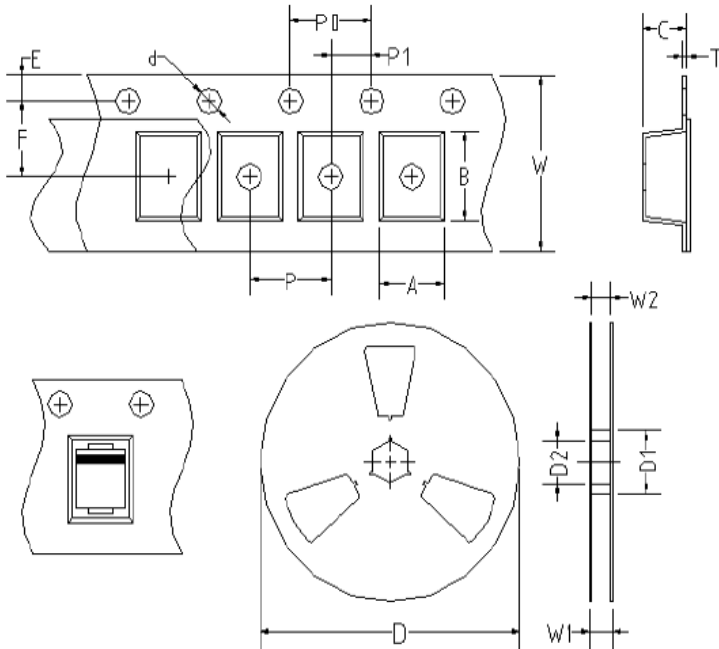

Item	Symbol	SMA/DO-214AC
		Unit: mm
Carrier width	A	3.77±0.15
Carrier length	B	5.70±0.15
Carrier depth	C	2.45±0.15
Sprocket hole	d	1.55±0.10
Reel outside diameter	D	330±1.0
Reel inner diameter	D1	75±1.0
Feed hole diameter	D2	13.5±1.0
Sprocket hole position	E	1.75±0.1
Punch hole position	F	5.50±0.05
Sprocket hole pitch	P	8.00±0.10
Carrier pitch	P0	4.00±0.10
Embossment center	P1	2.00±0.10
Tape thickness	T	0.25±0.10
Tape width	W	12.00±0.15
Reel width	W1	18.1±1.5
Reel inner width	W2	13.5±1.0

■ Quantity

Package Type	Reel Diameters	Reel
	(mm)	PCS
SMA/DO-214AC	330	3,000

■ Warehouse Storage Conditions of product

- Storage Condition:
 - Storage Temperature: -10°C~+40°C
 - Working Temperature:- 40°C~+85°C
 - Keep away from corrosive atmosphere and sunlight.
- Period of Storage: 1 year