



Model no. : UMT-8523FSA

Miniature Audio Transducer (External drive circuitry)

◆ FEATURES

- ◆ Compact
Small and Slim Size of 8.5mmW×8.5mmL×3.0mmH
- ◆ Low Profile Design
- ◆ For Reflow Process
- ◆ Side Sound port
- ◆ Tape and Reel Packing
- ◆ RoHS Compliant and Lead Free are Applied

◆ SPECIFICATIONS

Rated Voltage	V p-p	3.6
Operating Voltage	V p-p	2.5~4.5
● Rated Current	mA	Max 100
Coil Resistance	Ω	16±3
● Sound output at 10cm	dB	Min 85(Typ90)
Resonant Frequency	Hz	2,730
Operating Temperature	°C	-40 ~ +85
Storage Temperature	°C	-40 ~ +85
Weight	g	Max 0.5

- Value Applying Rated Voltage (2,730Hz, ½ duty, square wave)

◆ DIMENSIONS

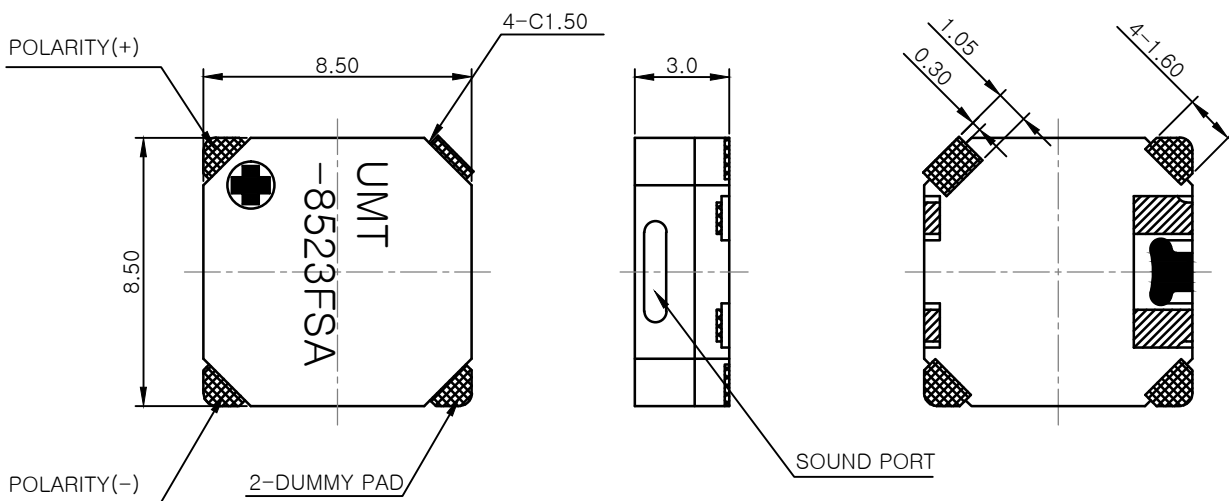

UNIT : mm
TOLERANCE : ±0.2
CASE MATERIAL : LCP(Black)