

RoHS Compliant

REV	DATE	DESCRIPTION	ECN NO.	NAME
A	18.08.10	NEW RELEASE		Aaron

M12 CONNECTOR PANEL FEMALE TYPE

NOTE:

- MATERIAL:
CONTACT: BRASS
O-RING: SILICONE
SHELL: BRASS
HOUSING/COVER:
HIGH TEMPERATURE PLASTIC, UL94V-0,
COLOR:BLACK
- PLATING:
CONTACT:1~3u".GOLD PLATED
UNDER PLATE: NICKEL
NUT: NICKEL PLATED
SHELL: NICKEL PLATED
- PACKING: TRAY

4. PART NO.:
G3402-1400XXX1-00

0: FOR KEY 0° 0: A-CODE
1: FOR KEY 45° 1: D-CODE

0: 8 PIN
1: 4 PIN
2: 5 PIN
3: 12 PIN
4: 17 PIN

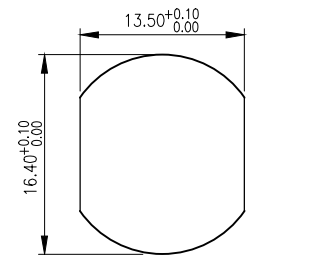
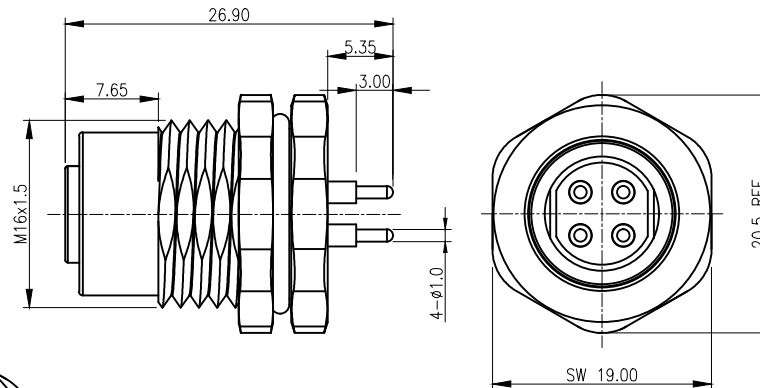
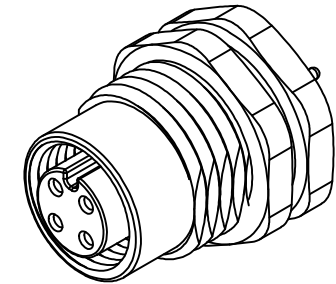

PANEL CUT
FOR PANEL THICKNESS MAX OF 4.5mm

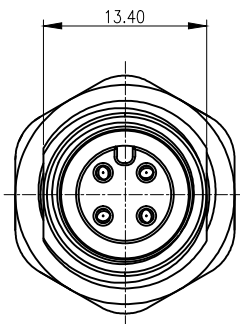

G3402-14000101-00

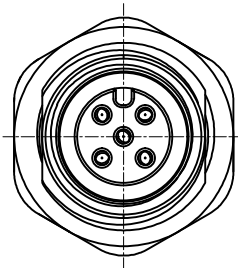

G3402-14000201-00

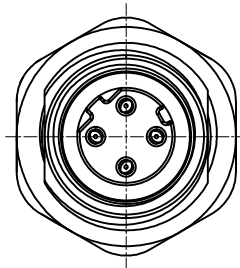

G3402-14000111-00

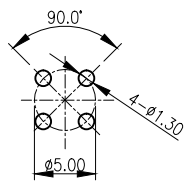

PCB LAYOUT
FOR G3402-14000101-00

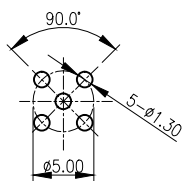

PCB LAYOUT
FOR G3402-14000201-00

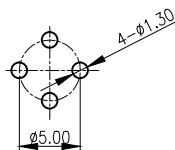

PCB LAYOUT
FOR G3402-14000111-00

TECHNICAL DATA	G3402-14000101-00 G3402-14000111-00	G3402-14000201-00
RATED VOLTAGE	250V	125V
RATED IMPULSE VOLTAGE	2500V	1500V
RATED CURRENT	4A	4A
WATERPROOF RATE	IP68	IP68
TEMPERATURE RANGE	-40°C~85°C	-40°C~85°C

GENERAL TOLERANCE	WIESON TECHNOLOGIES CO., LTD	PART NO.: G3402-1400XXX1-00
X.X = ±0.20	DRAWN BY: Aaron	DRAWING NO. G3402-1400XXX1-00
X.XX = ±0.15	CHECKED BY:	DRAWING SIZE 1.7: 1 A4
X.X* = ±3*	APPROVED BY:	UNIT mm
☉	SORTING NO. WST	PAGE 2 OF 3