

REV	DATE	DESCRIPTION	ECN NO.	NAME
A	18.08.10	NEW RELEASE		Aaron

**RoHS Compliant**

# M12 8P CONNECTOR PANEL MALE TYPE (D-CODE)

NOTE:

- MATERIAL:  
 CONTACT: BRASS  
 O-RING: SILICONE  
 SHELL: BRASS  
 HOUSING/COVER:  
 HIGH TEMPERATURE PLASTIC, UL94V-0, COLOR:BLACK
- PLATING:  
 CONTACT:1~3u".GOLD PLATED  
 UNDER PLATE: NICKEL  
 NUT: NICKEL PLATED  
 SHELL: NICKEL PLATED
- PACKING: TRAY

4. PART NO.:  
 GM3401-0XXXXX01-00  
 00: FOR KEY 0°  
 01: FOR KEY 45°

A  
B  
C  
D  
E

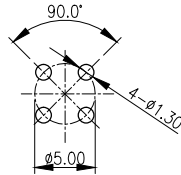

PCB LAYOUT FOR G3401-XXXX0001-00

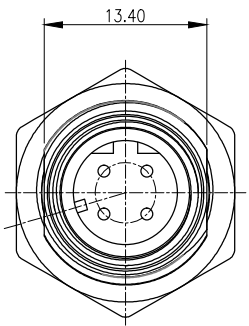

G3401-XXXX0001-00

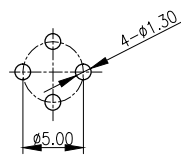
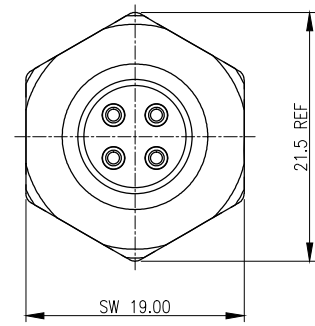
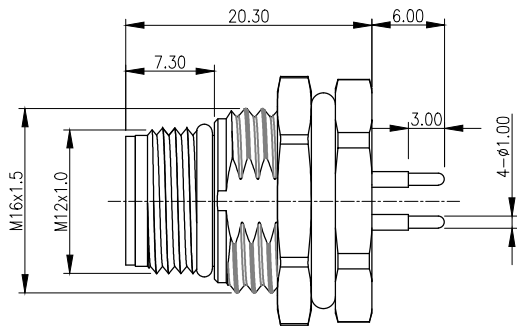

PCB LAYOUT FOR G3401-XXXX0101-00

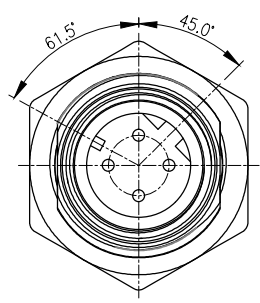

G3401-XXXX0101-00

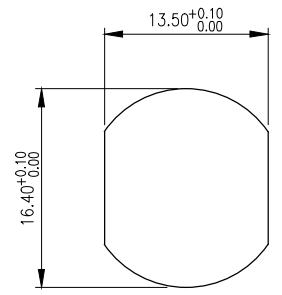

PANEL CUT FOR PANEL THICKNESS MAX OF 4.5mm

TECHNICAL DATA	G3401-XXXXXX01-00
RATED VOLTAGE	250V
RATED IMPULSE VOLTAGE	2500V
RATED CURRENT	4A
WATERPROOF RATE	IP68
TEMPERATURE RANGE	-40°C~85°C

GENERAL TOLERANCE X.X = ±0.20 X.XX = ±0.15 X.X' = ±3'	WIESON TECHNOLOGIES CO., LTD		PART NO.: G3402-XXXXXX01-00	
	WIESON	DRAWN BY: Aaron	DRAWING NO.:	G3402-XXXXXX01-00
	CHECKED BY:	DRAWING SIZE:	1.7: 1	A4
	APPROVED BY:	UNIT:	mm	
	SORTING NO.:	WST	PAGE:	2 OF 2