

6174 SERIES MICRO SD (TRANS FLASH) CARD SOCKET FLIP-UP TYPE

NOTE

1.MATERIAL :

HOUSING : HIGH TEMPERATURE PLASTIC(UL94V-0), BLACK.
COVER : HIGH TEMPERATURE PLASTIC(UL94V-0), BLACK
TERMINAL : COPPER ALLOY.
GROUND-LEG : COPPER ALLOY.
SHELL : STAINLESS STEEL.

2.PLATED :

TERMINAL PLATING: SEE ORDER INFORMATION:

△ SELECTIVE Au IN CONTACT AREA, 100u" min. Sn/Pb(FOR 6174-5500**)OR Sn(FOR G6174-5500**) IN SOLDER TAIL AREA, BOTH OVER 50u" min. Ni UNDER PLATED OVERALL

△ FULL Au OVER 50u" min. Ni UNDER PLATED OVERALL

△△△ GROUND-LEG PLATING: 1. 100u" MIN. Sn OR Sn/Pb FOR TERMINAL SELECTIVE Au.
2. GOLD FLASH FOR TERMINAL FULL Au.

3.ORDER INFORMATION :

*6174-55 00 *

COVER LOGO
0 : WITH LOGO
1 : W/O LOGO

TERMINAL PLATING

0: 1u" min. Au
1: 3u" min. Au
2: 15u" min. Au
3: 30u" min. Au
(0~3 TO SELECTIVE Au)

4: 1u" min. Au
5: 3u" min. Au
6: 3u" min. Au
7: 15u" min. Au
8: 30u" min. Au
(5~8 TO FULL Au)

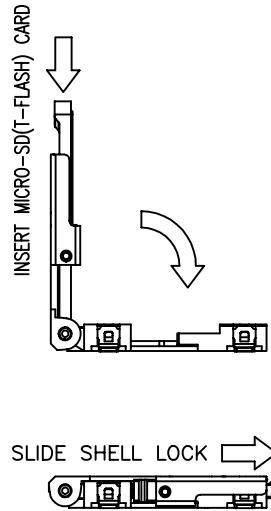
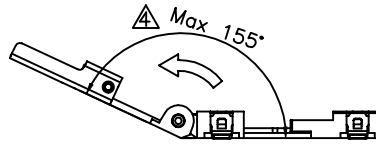

REV	DATE	DESCRIPTION	ECN NO.	NAME
A	06.01.17	NEW RELEASE		SAM HO
B	05.08.05	△ ADD PLATING OPTION	AK0508009	COLA
C	05.09.08	△ ADD GROUND-LEG FULL Au PLATING	AK0509007	JOY
D	05.09.14	△ ADD Sn/Pb PLATING OPTION	AK0509021	JOY
E	06.01.11	△ ADD CHAMFER ADD VIEW	AK0601018	winner

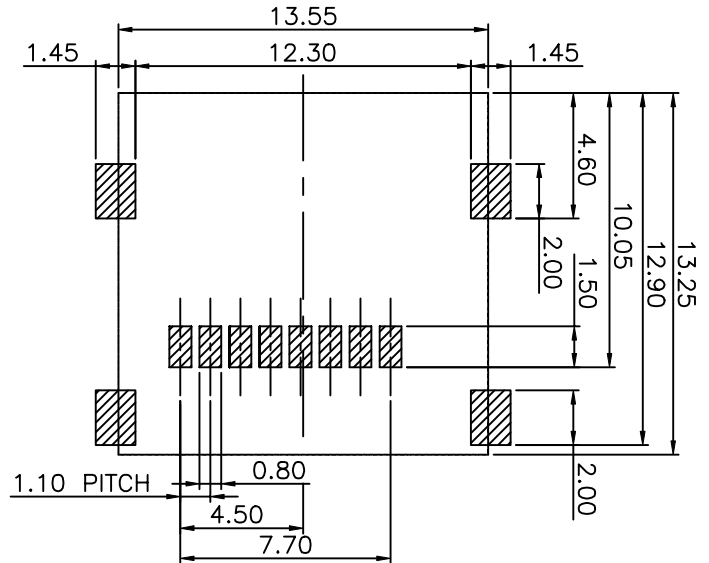
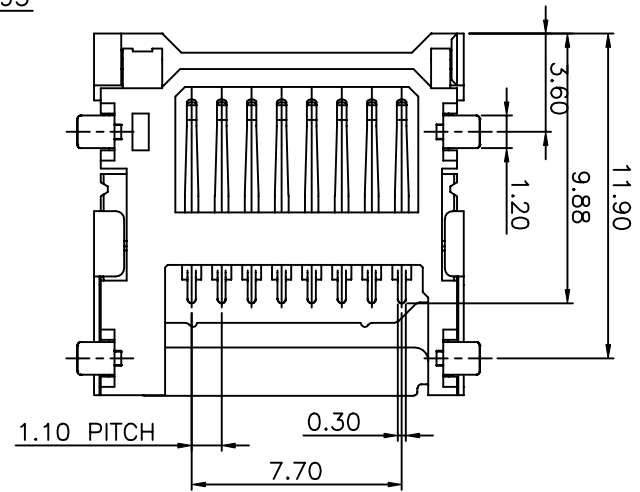
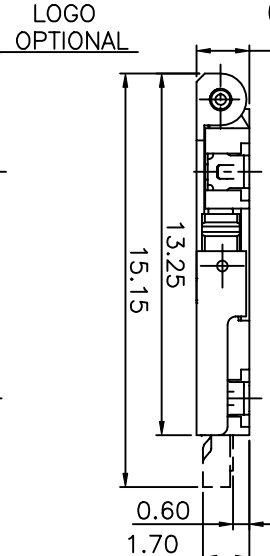
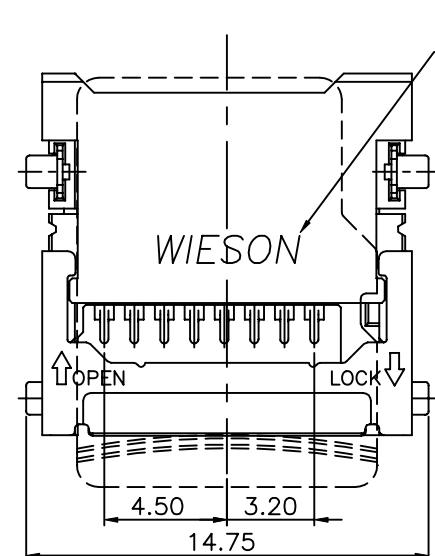
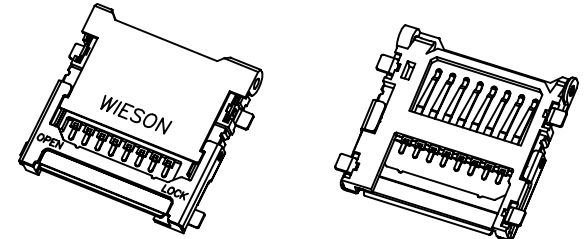

RECOMMENDED PCB LAYOUT (TOP VIEW)
TOLERANCE: ±0.05mm

GENERAL TOLERANCE ± 0.25 mm GENERAL ANGLE TOLERANCE ±3°	WIESON TECHNOLOGIES CO., LTD	PART NO.: △ *6174-5500**	
	DRAWN BY	SAM HO (WST)	DRAWING NO. *6174-5500**
	CHECKED BY	JIMMY	DRAWING SIZE 5 : 1 A3
	APPROVED BY	JERRY	UNIT mm
	SORTING NO.	WSC	PAGE 1 OF 1

ISSUED

[ARTICLE:044033 V4]